

## ΔΕΛΤΙΟ ΠΛΗΡΟΦΟΡΙΩΝ 1 Α

Δευτέρα 27 Σεπτεμβρίου 2010

### ΑΦΟΡΑ ΜΟΝΟ ΤΑ ΠΛΗΡΩΜΑΤΑ ΠΟΥ ΣΥΜΜΕΤΕΧΟΥΝ ΜΕ ΙΣΤΟΡΙΚΑ ΑΥΤΟΚΙΝΗΤΑ

#### **Σάββατο 2 Οκτωβρίου**

Μετά την ειδική 3 Καρούτες 1, τα πληρώματα θα ακολουθήσουν κανονικά το road book του αγώνα μέχρι τον ΣΕΧ 3Α, όπου, αφού κτυπήσουν χρόνο, θα παραδώσουν το καρνέ τους.

Η ανασυγκρότηση ΔΕΝ ισχύει για τα ιστορικά αυτοκίνητα.

Επίσης δεν ισχύει το flexi service.

Από τον ΣΕΧ 3Α θα πάνε αμέσως στον ΣΕΧ 3Β. Ιδανικός χρόνος μεταξύ ΣΕΧ 3Α και 3Β δεν υπάρχει.

Για τα πληρώματα αυτά ο ΣΕΧ 3Β θεωρείται ότι είναι ο ΣΕΧ 6Β.

Από εκεί εισέρχονται στο χώρο του service και κάνουν service για μέγιστο χρόνο 45 λεπτών.

Μετά το service κτυπούν χρόνο στον ΣΕΧ 6C και εισέρχονται κατευθείαν στο βραδινό parc ferme.

Η προάφιξη στον ΣΕΧ 6C επιτρέπεται.

Το καρνέ θα αναφέρει τους ΣΕΧ του ευρωπαϊκού αγώνα.

#### **Κυριακή 3 Οκτωβρίου**

#### **ROAD BOOK**







Την Κυριακή 3 Οκτωβρίου, τα πληρώματα με ιστορικά αυτοκίνητα πρέπει να ακολουθήσουν το συνημμένο road book από τον ΣΕΧ 9, Βωξίτες 2 μέχρι τον τερματισμό τους στον Προβλήτα, παραλείποντας και το τελευταίο service του ευρωπαϊκού αγώνα.





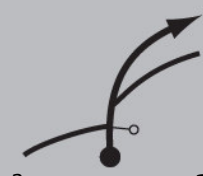

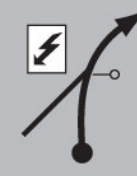
Ο ιδανικός τους χρόνος από ΣΕΧ 9 μέχρι τον ΣΕΧ 9Α (τερματισμός), είναι 50' λεπτά.

Η προάφιξη στον τερματισμό (9Α) απαγορεύεται.

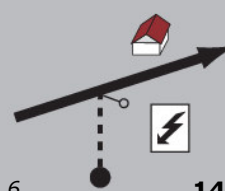
Νίκος Πασαλής

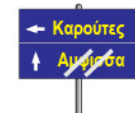
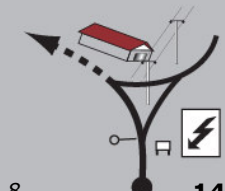







Αλυτάρχης

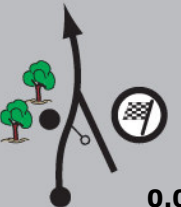

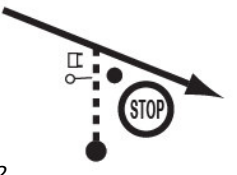



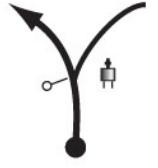
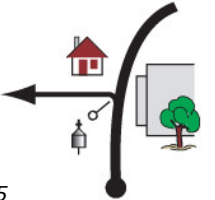

| T.C.9 BAUXITES             |            | DISTANCE  |   | DAY 2             | PAGE |
|----------------------------|------------|---|---|-------------------|------|
| T.C.9A ITEA Finish         |            | 47.46 Km  |   | R.SECTION 20      | 81   |
| S.S. 9 Bauxites 2 23.28 Km |            | AVERAGE SPEED   |   | TARGET TIME 00:50 |      |
| 56.95 Km/h                 |            |   |   |                   |      |
| Total Km                   | Partial Km | DIRECTION   | INFORMATION   | Km to run         |      |
| 0.00                       | 0.00       | 1    | N-38.27.067 E-22.25.105 Alt 44<br><br> START S.S. 9<br>Bauxites 2<br>23.28 km | 47.46             |      |
| 2.02                       | 2.02       | 2    |   | 45.44             |      |
| 2.63                       | 0.61       | 3    |   | 44.83             |      |
| 4.07                       | 1.44       | 4  | N-38.28.359 E-22.23.979 Alt 309<br> 9-1  | 43.39             |      |
| 7.38                       | 3.31       | 5  |   | 40.08             |      |

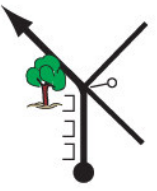

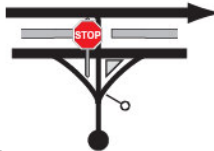

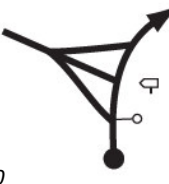

| T.C.9 BAUXITES             |            | DISTANCE   |  | DAY 2             | PAGE |
|----------------------------|------------|--|--|-------------------|------|
| T.C.9A ITEA Finish         |            | 47.46 Km   |  | R.SECTION 20      | 82   |
| S.S. 9 Bauxites 2 23.28 Km |            | AVERAGE SPEED  |  | TARGET TIME 00:50 |      |
| 56.95 Km/h                 |            |  |  |                   |      |
| Total Km                   | Partial Km | DIRECTION  | INFORMATION  | Km to run         |      |
| 8.36                       | 0.98       | 6     | N-38.29.750 E-22.22.033 Alt 502<br> 9-2 | 39.10             |      |
| 8.51                       | 0.15       | 7     | ASPHALT<br>                             | 38.95             |      |
| 8.78                       | 0.27       | 8     | N-38.29.970 E-22.22.049 Alt 502<br> 9-3 | 38.68             |      |
| 9.50                       | 0.72       | 9   |  | 37.96             |      |
| 10.34                      | 0.84       | 10  |                                       | 37.12             |      |

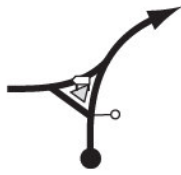

| T.C.9 BAUXITES            |            |           | DISTANCE   | DAY 2             | PAGE      |
|---------------------------|------------|-----------|--|-------------------|-----------|
| T.C.9A ITEA Finish        |            |           | 47.46 Km   | R.SECTION 20      | 83        |
| S.S.9 Bauxites 2 23.28 Km |            |           | AVERAGE SPEED                                      | TARGET TIME 00:50 |           |
| Total Km                  | Partial Km | DIRECTION | INFORMATION  |                   | Km to run |
| 12.87                     | 2.53       | 11        |  |                   | 34.59     |
| 13.64                     | 0.77       | 12        | N-38.31.899 E-22.20.674 Alt 856<br><br><br><br>9-4 |                   | 33.82     |
| 16.43                     | 2.79       | 13        | N-38.32.707 E-22.19.543 Alt 1010<br><br>9-5        |                   | 31.03     |
| 17.41                     | 0.98       | 14        |  |                   | 30.05     |
| 17.61                     | 0.20       | 15        |  |                   | 29.85     |

| T.C.9 BAUXITES            |            |           | DISTANCE                                   | DAY 2             | PAGE      |
|---------------------------|------------|-----------|--|-------------------|-----------|
| T.C.9A ITEA Finish        |            |           | 47.46 Km                                   | R.SECTION 20      | 84        |
| S.S.9 Bauxites 2 23.28 Km |            |           | AVERAGE SPEED                              | TARGET TIME 00:50 |           |
| Total Km                  | Partial Km | DIRECTION | INFORMATION                                |                   | Km to run |
| 17.76                     | 0.15       | 16        | N-38.33.265 E-22.19.340 Alt 973<br><br>9-6 |                   | 29.70     |
| 18.28                     | 0.52       | 17        |  |                   | 29.18     |
| 19.67                     | 1.39       | 18        | N-38.34.036 E-22.19.769 Alt 929<br>9-7     |                   | 27.79     |
| 20.56                     | 0.89       | 19        |  |                   | 26.90     |
| 22.65                     | 2.09       | 20        | N-38.34.457 E-22.20.520 Alt 894<br><br>9-8 |                   | 24.81     |

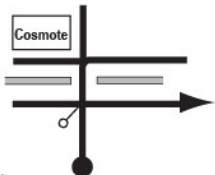
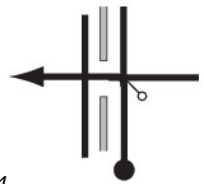
| T.C.9 BAUXITES     |            | DISTANCE   | DAY 2   | PAGE              |
|--------------------|------------|--|---|-------------------|
| T.C.9A ITEA Finish |            | 47.46 Km   | R.SECTION 20  | 85                |
| S.S. 9 Bauxites 2  |            | 23.28 Km   | AVERAGE SPEED   | TARGET TIME 00:50 |
|                    |            |  | 56.95 Km/h  |                   |
| Total Km           | Partial Km | DIRECTION  | INFORMATION   | Km to run         |
| 23.28              | 0.63       | 21    | N-38.34.327 E-22.20.844 Alt 897<br> END S.S. 9 Bauxites 2  | 24.18             |
| 23.48              | 0.20       | 22    | N-38.34.266 E-22.20.950 Alt 892<br><br> STOP S.S. 9 Bauxites 2<br>ASPHALT | 23.98             |
| 31.17              | 7.69       | 23    |    | 16.29             |
| 31.94              | 0.77       | 24  | Entrance to AMFISSA<br>Low Speed !!   | 15.52             |
| 32.26              | 0.32       | 25  | <br> ATTENTION Narrow Road !!   | 15.20             |

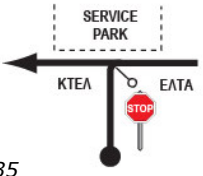
| T.C.9 BAUXITES     |            | DISTANCE   | DAY 2  | PAGE              |
|--------------------|------------|--|--|-------------------|
| T.C.9A ITEA Finish |            | 47.46 Km   | R.SECTION 20   | 86                |
| S.S. 9 Bauxites 2  |            | 23.28 Km   | AVERAGE SPEED  | TARGET TIME 00:50 |
|                    |            |  | 56.95 Km/h   |                   |
| Total Km           | Partial Km | DIRECTION  | INFORMATION  | Km to run         |
| 32.60              | 0.34       | 26    |  | 14.86             |
| 33.22              | 0.62       | 27    | Exit from AMFISSA  | 14.24             |
| 33.86              | 0.64       | 28    | <br>ATTENTION !!<br>Entrance to Main Road | 13.60             |
| 34.69              | 0.83       | 29  |   | 12.77             |
| 41.06              | 6.37       | 30  |   | 6.40              |

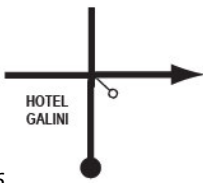
| T.C.9 BAUXITES             |            |  | DISTANCE  | DAY 2             | PAGE |
|----------------------------|------------|--|---|-------------------|------|
| T.C.9A ITEA Finish         |            |  | 47.46 Km  | R.SECTION 20      | 87   |
| S.S. 9 Bauxites 2 23.28 Km |            |  | AVERAGE SPEED   | TARGET TIME 00:50 |      |
| Total Km                   | Partial Km | DIRECTION  | INFORMATION   | Km to run         |      |
| 45.95                      | 4.89       | 31    |                        | 1.51              |      |
| 46.50                      | 0.55       | 32    | <br>METAMORFOSEOS Str. | 0.96              |      |
| 46.73                      | 0.23       | 33    | ASTIGOS Str.  | 0.73              |      |
| 46.92                      | 0.19       | 34  | <br>BALI Str.        | 0.54              |      |
| 47.19                      | 0.27       | 35  | 28th OCTOBER Str.   | 0.27              |      |

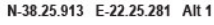
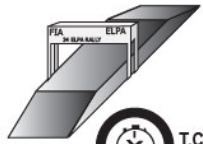
| T.C.9 BAUXITES             |            |  | DISTANCE  | DAY 2             | PAGE |
|----------------------------|------------|--|---|-------------------|------|
| T.C.9A ITEA Finish         |            |  | 47.46 Km  | R.SECTION 20      | 88   |
| S.S. 9 Bauxites 2 23.28 Km |            |  | AVERAGE SPEED   | TARGET TIME 00:50 |      |
| Total Km                   | Partial Km | DIRECTION  | INFORMATION   | Km to run         |      |
| 47.40                      | 0.21       | 36  | <br>HOTEL GALINI   | 0.06              |      |
| 47.46                      | 0.06       | 37  | <br><br>T.C. 12C<br>ITEA Finish | 0.00              |      |